

SAFETY PRECAUTIONS

In order to prevent any fatal accidents caused by misoperation or mishandling the monitor, be fully aware of all the following precautions.

WARNINGS

To prevent fire or shock hazard, do not expose this monitor to rain or moisture. Dangerous high voltages are present inside the unit. Do not remove the back cover of the cabinet. When servicing the monitor, consult qualified service personnel. Never try to service it yourself.

WARNING : THIS APPARATUS MUST BE EARTHED.

Machine Noise Information Ordinance 3. GSGV, January 18, 1991: The sound pressure level at the operator position is equal or less than 70 dB(A) according to ISO 7779.

Improper operations, in particular alternation of high voltage or changing the type of tube may result in x-ray emission of considerable dose. A unit altered in such a way no longer meets the standards of certification, and must therefore no longer be operated.

This monitor is equipped with a 3-blade grounding-type plug to satisfy FCC rule. If you are unable to insert the plug into the outlet, contact your electrician.

FCC INFORMATION (U.S.A. only)

CAUTION: Changes or modification not approved by JVC could void the user's authority to operate the equipment.

NOTE: This equipment has been tested and found to comply with the limits for a Class B digital device, pursuant to Part 15 of the FCC Rules. These limits are designed to provide reasonable protection against harmful interference in a residential installation. This equipment generates, uses and can radiate radio frequency energy and, if not installed and used in accordance with the instructions, may cause harmful interference to radio communications. However, there is no guarantee that interference will not occur in a particular installation. If this equipment does cause harmful interference to radio or television reception, which can be determined by turning the equipment off and on, the user is encouraged to try to correct the interference by one or more of the following measures:

- Reorient or relocate the receiving antenna.
- Increase the separation between the equipment and receiver.
- Connect the equipment into an outlet on a circuit different from that to which the receiver is connected.
- Consult the dealer or an experienced radio/TV technician for help.

Notice (U.S.A. only)

This product utilizes both a Cathode Ray Tube (CRT) and other components that contain lead. Disposal of these materials may be regulated in your community due to environmental considerations. For disposal or recycling information please contact your local authorities, or the Electronics Industries Alliance: <<http://www.eiae.org>>

POWER CONNECTION

The power supply voltage rating of this product is AC 120 V (For U.S.A. and Canada only) and AC 230 V (For European countries or United Kingdom), the power cord attached conforms to the following power supply voltage and countries. Use only the power cord designated to ensure Safety and EMC regulations of each countries.

Power cord



Power supply voltage : AC 120 V
Countries : U.S.A. and Canada

AC 230 V
European countries

AC 230 V
United Kingdom

Warning:

- Do not use the same Power Cord for AC 120 V as for AC 230 V. Doing so may cause malfunction, electric shock or fire.

Note for the United Kingdom power cord only

The plug on the United Kingdom power cord has a built-in fuse. When replacing the fuse, be sure to use only a correctly rated approved type, re-fit the fuse cover.
(Consult your dealer or qualified service personnel.)

How to replace the fuse

Open the fuse compartment with the blade screw driver, and replace the fuse.

(* An example is shown in the illustration.)

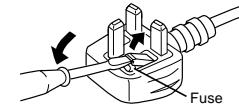

SCREEN BURN

- It is not recommended to keep a certain still image displayed on screen for a long time as well as displaying extremely bright images on screen. This may cause a burning (sticking) phenomenon on the screen of cathode-ray tube. This problem does not occur as far as displaying normal video playback motion images.

CONTENTS

SAFETY PRECAUTIONS	2
CONTROLS AND FEATURES	4
CONTROLS AND FEATURES (INPUT CARD: OPTIONAL)	7
PREPARATION	8
HOW TO HANDLE BASIC OPERATIONS	9
HOW TO USE THE MENU FUNCTIONS	11
HOW TO INITIALIZE THE SETTING	14
BASIC CONNECTION EXAMPLE	15
HOW TO USE EXTERNAL CONTROL	17
TROUBLESHOOTING	18
SPECIFICATIONS	19
APPENDIX	20

PRECAUTIONS

- Use only the power source specified on the unit.
(120 V AC/230 V AC, 50 Hz/60Hz)
- When not using this unit for a long period of time, or when cleaning it, be sure to disconnect the power plug from the AC outlet.
- Do not allow anything to rest on the power cord. And do not place this unit where people will tread on the cord. Do not overload wall outlets or power cords as this can result in a fire or electric shock.
- Avoid using this unit under the following conditions:
 - in extremely hot, cold or humid places,
 - in dusty places,
 - near appliances generating strong magnetic fields,
 - in places subject to direct sunlight,
 - in badly ventilated places,
 - in automobiles with doors closed.
- Do not cover the ventilation slots while in operation as this could obstruct the required ventilation flow.
- When dust accumulates on the screen surface, clean it with a soft cloth.

- Unplug this unit from the AC outlet and refer servicing to qualified service personnel under the following conditions:
 - when the power cord is frayed or the plug is damaged,
 - if liquid has been spilled into the unit,
 - if the unit has been dropped or the cabinet has been damaged,
 - when the unit exhibits a distinct change in performance.
- Do not attempt to service this unit yourself as opening or removing covers may expose you to dangerous voltage or other hazards. Always refer servicing to qualified service personnel.
- When replacement parts are required, have the service personnel verify in writing that the replacement parts he/she uses have the same safety characteristics as the original parts. Use of manufacturer's specified replacement parts can prevent fire, shock, or other hazards.
- Upon completion of any servicing or repair work to this unit, please ask the service personnel to perform the safety check described in the manufacturer's service literature.
- When this unit reaches the end of its useful life, improper disposal could result in a picture tube implosion. Ask qualified service personnel to dispose of this unit.

CONTROLS AND FEATURES

FRONT VIEW

<Front Panel>

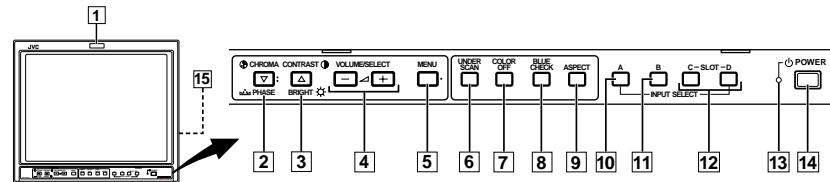

- 1 Tally lamp**
Lights when the tally control signal is ON. The tally control signal is input through the REMOTE (external control) remote terminal. For details, refer to Page 17.
- 2 Chroma/Phase button [CHROMA/PHASE]**
Press this button to activate the picture color density adjustment mode or picture hue adjustment mode. Each time you press the button, the adjustment item changes.
Picture color density ⇄ Picture hue
Adjust the value with the VOLUME/SELECT buttons [4]. Also used as a control button in the menu function mode.
- 3 Contrast/Brightness button [CONTRAST/BRIGHT]**
Press this button to activate the picture contrast adjustment mode or picture brightness adjustment mode. Each time you press the button, the adjustment item changes.
Picture contrast ⇄ Picture brightness
Adjust the value with the VOLUME/SELECT buttons [4]. Also used as a control button in the menu function mode.
- 4 Volume/Select buttons [VOLUME/SELECT - / +]**
Adjusts the speaker volume. Also used as a control button in the menu function mode.
- 5 Menu button [MENU]**
Displays and disappears the <MENU> screen. Pressing the CHROMA/PHASE button [2] with the Menu button depressed will display the <SET-UP MENU> screen.
- 6 Under Scan button [UNDER SCAN]**
Reduces the screen size to display the entire image. Press the button again to cancel Under Scan. When selected, the Under Scan button lights.
- 7 Color Off button [COLOR OFF]**
Cuts color signals to display a black and white image. Press the button again to restore the original color. When selected, the COLOR OFF button lights.
Note:
• This function is invalid with RGB input.
- 8 Blue Check button [BLUE CHECK]**
Cuts red and green signal components. Only blue signal components are shown. Press the button again to restore the normal image. When selected, this button lights.
- 9 Aspect button [ASPECT]**
Press this button to change the aspect ratio from 4:3 to 16:9.
- 10 Input A (VIDEO) button [INPUT SELECT A]**
Selects the video and audio signals input to the VIDEO A [18] and AUDIO A [21] terminals on the rear panel. The button lights when selected.
- 11 Input B (VIDEO Y/C) button [INPUT SELECT B]**
Selects the video and audio signals input to the VIDEO B [19] or VIDEO B (Y/C) [20] and AUDIO B [22] terminals on the rear panel. The button lights when selected.
Note:
• The VIDEO B terminals include a video terminal (BNC connector) and a Y/C terminal (mini-DIN 4-pin connector). The Y/C (S-video) terminal has priority.
- 12 Input C/D (Slot) buttons [INPUT SELECT C/D (SLOT)]**
Selects the signals to be input via the input cards installed in the rear panel card slots.
C, D: Selects the image from the input card in the slot. For details on input connectors and using the INPUT SELECT button, refer to page 7.
- 13 Power indicator**
Unit : The main power is OFF.
Orange : The main power is ON, but the monitor's power is OFF (in the stand-by mode).
Green : The main power is ON, and the monitor's power is ON (in the normal operation mode).
- 14 Power switch [POWER]**
Press the power switch to turn the monitor's power ON or OFF when the main power is ON.
Note:
• When RUSH DELAY is set to SLOW, it takes about three seconds before power is actually supplied after the power switch is pressed.
- 15 Speaker**
A built-in speaker is located inside the right side panel when the monitor is viewed from the front.

REAR VIEW

<Rear Panel>

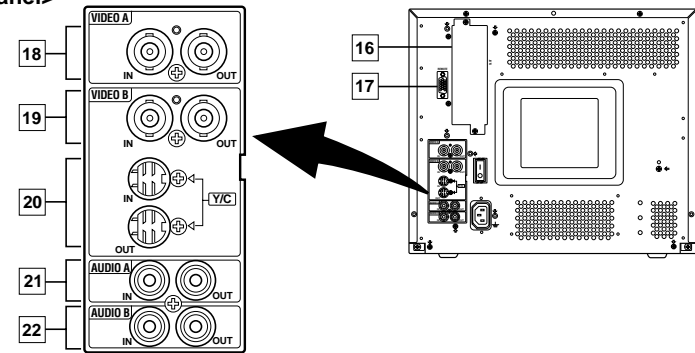

- 16 Input card slot (SLOT)**
Optional input cards can be installed in this slot. Input cards are not provided when you purchase this monitor.
- 17 REMOTE (external control) terminal**
Connect this terminal to an external control unit to enable remote operation of the monitor. Refer to the HOW TO USE EXTERNAL CONTROL on page 17 for more details.
- 18 Video A terminals [VIDEO A IN/OUT]**
Video signal input (IN) and output (OUT) terminals. The output terminal is bridge-connected.
IN : Video signal input terminal
OUT : Bridge-connected video signal output terminal
Notes:
• For corresponding audio signals, use the AUDIO A terminals [21].
• Also refer to BASIC CONNECTION EXAMPLE on page 15.
- 19 Video B terminals [VIDEO B IN/OUT]**
Video signal input (IN) and output (OUT) terminals. The output terminal is bridge-connected.
IN : Video signal input terminal
OUT : Bridge-connected video signal output terminal
Notes:
• For corresponding video signals, use the VIDEO A terminal [18].
• Also refer to BASIC CONNECTION EXAMPLE on pages 15 and 16.
- 20 Video B (Y/C) terminals [VIDEO B Y/C IN/OUT]**
Y/C (S-video) signal input (IN) and output (OUT) terminals. The output terminal is bridge-connected.
IN : Y/C-separated (S-video) video signal input terminal
OUT : Bridge-connected Y/C-separated (S-video) signal output terminal
- 21 Audio A terminals [AUDIO A IN/OUT]**
Input (IN) and output (OUT) terminals for the audio signal corresponding to the VIDEO A terminals [18]. The output terminal is bridge-connected.
IN : Audio signal input terminal
OUT : Bridge-connected audio signal output terminal
Notes:
• For corresponding audio signals, use the AUDIO B terminals [22].
• When both VIDEO B terminals are connected (input) at the same time, the Y/C terminal has priority.
• Also refer to BASIC CONNECTION EXAMPLE on page 16.
- 22 Audio B terminals [AUDIO B IN/OUT]**
Input (IN) and output (OUT) terminals for the audio signals corresponding to the VIDEO B terminals [19] or VIDEO B (Y/C) terminals [20]. The output terminal is bridge-connected.
IN : Audio signal input terminal
OUT : Bridge-connected audio signal output terminal
Notes:
• For corresponding video signals, use the VIDEO B terminals [19] or VIDEO B (Y/C) terminals [20].
• Also refer to BASIC CONNECTION EXAMPLE on pages 15 and 16.

CONTROLS AND FEATURES (cont'd)

REAR VIEW

<Rear Panel>

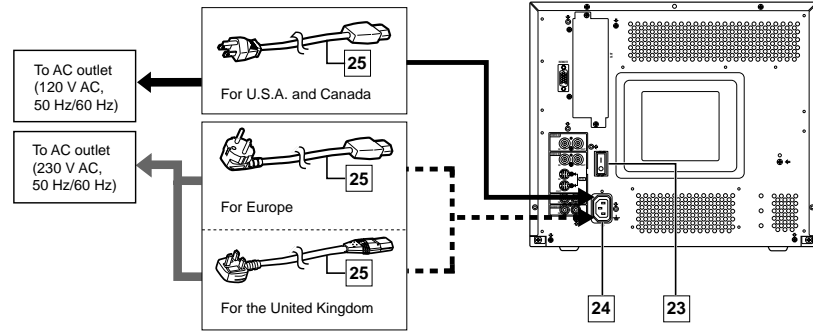

23 Main power switch

Press the switch to turn the main power ON or OFF. When the main power is ON, the power lamp on the front panel lights in orange and the monitor enters the stand-by mode.

I : ON O : OFF

24 AC inlet [AC IN]

Power input connector. Connect the provided AC power cord (25) to an AC outlet (120 V AC or 230 V AC, 50 Hz/60 Hz).

25 Power cord

Connects the provided power cord (120 V AC or 230 V AC, 50 Hz/60 Hz) to the AC IN connector (24).

Caution:

In North America (USA and Canada), this monitor comes with one power cable. In Europe and the United Kingdom, two power cables are provided (one for use in continental European countries and the other for the UK). Be sure to use the power cable that is appropriate for the AC outlets used in your region. If none of the power cables provided is suitable, please contact your dealer or qualified service personnel to obtain the correct type of power cable.

CONTROLS AND FEATURES (INPUT CARD: OPTIONAL)

COMPONENT/RGB INPUT CARD (OPTIONAL: IF-C01COMG)

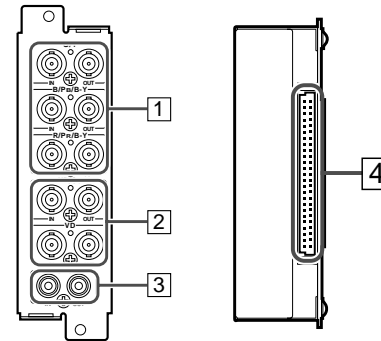

Compatible signal formats:
480/50i, 480/60i

1 Video input/output terminals

Input (IN) and output (OUT) terminals for component (color deference) or RGB signals. The IN and OUT terminals are bridge-connected. (When no cable is connected to the OUT terminal, the input signal is automatically terminated.)
Select component signal : press INPUT SELECT C button
Select RGB signal : press INPUT SELECT D button

2 Synchronized signal input/output terminals

Input (IN) and output (OUT) terminals for the vertical, horizontal or complex synchronized signals. The synchronized signals from these terminals have priority over other terminals. When no synchronized signal is input to these terminals, the synchronized signal from the video input/output terminals (G/Y terminals) is valid. The IN and OUT terminals are bridge-connected. (When no cable is connected to the OUT terminal, the input signal is automatically terminated.)
External sync is available with RGB input only. G on SYNC cannot be used with RGB input.

3 Audio input/output terminals

Input (IN) and output (OUT) terminals for audio signals. The IN and OUT terminals are bridge-connected.

4 Connection terminal (to a Color Video Monitor)

Attach to the connection terminal of your color video monitor.

SDI INPUT CARD (OPTIONAL: IF-C01SDG)

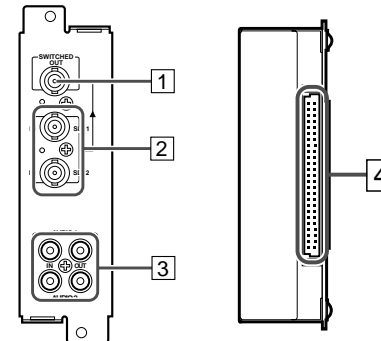

Compatible signal formats: 480/60i, 480/50i

Note:

- The optional input cards shown below cannot be used. Using any of these cards will void your warranty and may result in damage or malfunction.
- *Video input card (IF-C01PNG)
- *HD-SDI input card (IF-C01HSDG)

1 Output terminal for a selected component serial digital signal

Output terminal for a selected digital signal (the input displayed on the screen). The output signal is cable-compensated.

NOTE: When the monitor's main power is OFF, no digital signal is output.

In the standby mode, signals from the SDI 1 connector are output.

2 Input terminals for component serial digital signals

Input terminals for the digital signal.

Select SDI 1 : press INPUT SELECT C button

Select SDI 2 : press INPUT SELECT D button

3 Audio input/output terminals

Input (IN) and output (OUT) terminals for the analog signals corresponding to SDI 1 and SDI 2.

NOTE: This input card cannot decode audio data even if contained in the input digital signal.

4 Connection terminal (to a Color Video Monitor)

Attach to the connection terminal of your color video monitor.

PREPARATION

INSTALLING THE INPUT CARD

1. Turn off the Color Video Monitor's main power and unplug the power cable from the AC outlet.
2. Unscrew the screws and remove the slot cover from the slot (on the rear side of the monitor) in which you are going to install the card.

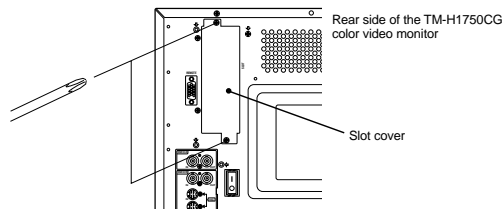

3. Insert the Input Card's board (green-colored) into the slot, fitting the board into the guide rails on the top and bottom of the slot.

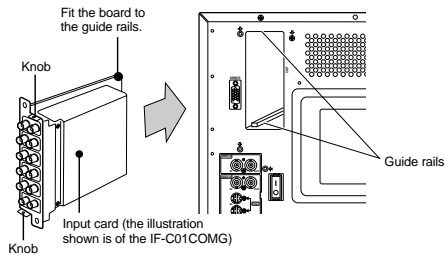

4. Push the Input Card in so that its front panel touches the monitor's rear panel.
5. Secure the Input Card by replacing the screws removed in Procedure 2.

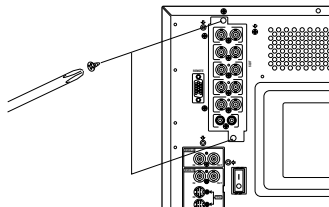

NOTE : Do not touch the terminal connected to the monitor or board pattern.
Do not remove slot covers from the monitor's slots if they are not in use.

HOW TO HANDLE BASIC OPERATIONS

BASIC OPERATION

1. Press the main power switch to turn on the power.
2. Press the POWER switch to turn on the power.



ON : Power turns ON. (Power indicator: lit)
Green : The main power is ON, and the monitor's power is ON (in the normal operation mode).
OFF : Power turns OFF. (Power indicator: unlit)
Orange : The main power is ON, but the monitor's power is OFF (in the standby mode)
Unlit : The main power is OFF.

3. Press the INPUT SELECT buttons to choose input.

Select video/audio signals input to terminals on the rear panel. The selected button lights in green.

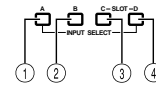

INPUT SELECT buttons	Terminals on the rear panel	
	Video signal input	Audio signal input
① Input A (VIDEO)	VIDEO A terminal	AUDIO A terminal
② Input B (VIDEO/Y/C)	VIDEO B terminal	AUDIO B terminal
	VIDEO B (Y/C) terminal	
③ Input C	Refer to page 7 for details about the input terminals on each card and the INPUT SELECT button.	
④ Input D		

Note: The Y/C (S-video) terminal has priority.

4. Press the VOLUME/SELECT buttons to adjust the speaker volume.



Press this button to display the speaker volume level on the screen.

+ : The Built-in speaker volume is increased. (00 → 50)
- : The Built-in speaker volume is decreased. (50 → 00)
* Screen indication will disappear about 10 seconds after operating.
* The on-screen display goes off when you press MENU button.

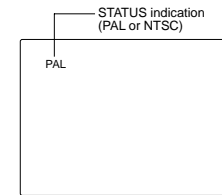

About the STATUS indication

- With the COLOR SYSTEM setting set to AUTO mode, when you turn on the power or select inputs, the color system indication appears for about 3 seconds on the screen while PAL or NTSC signals are being detected. It does not appear when receiving a B/W signal or when no signal is input. Refer to page 11 for more information about COLOR SYSTEM setting and page 12 for more information about STATUS indication setting.

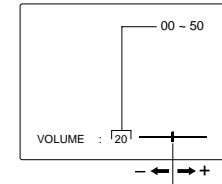

PICTURE ADJUSTMENT

1. Press select buttons corresponding to the item you want to adjust.

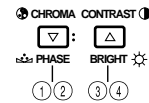

The item you select is displayed on the screen.

- ① Chroma control : Press the CHROMA/PHASE button once.
- ② Phase control : Press the CHROMA/PHASE button twice.
- ③ Contrast control : Press the CONTRAST/BRIGHT button once.
- ④ Brightness control : Press the CONTRAST/BRIGHT button twice.

* Pressing the CHROMA/PHASE button and CONTRAST/BRIGHT button alternately while the item is shown on screen restores the previous status. When no item is shown on screen, CHROMA and CONTRAST have priority.

2. Adjust with the VOLUME/SELECT buttons.



Items	VOLUME/SELECT button	
	-	+
CHROMA (Chroma)	lighter	deeper
PHASE (Phase)	reddish	greenish
CONTRAST (Contrast)	lower	higher
BRIGHT (Brightness)	darker	brighter

* Screen indication will disappear about 10 seconds after operating.
* The on-screen display goes off when you press MENU button.

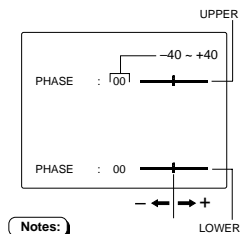

Notes:

- Phase control is effective only in the NTSC color system mode.
- Chroma control is not effective when receiving RGB and B/W or when no signal is input. (Except when a component signal is input.)
- When CHROMA is adjusted to "-40," the picture becomes less colorful.
- "NO EFFECT" is displayed (for about 3 seconds) when your selected function has no effect.
- To change the display position on screen, set UPPER or LOWER with ADJ. BAR POSI.

HOW TO HANDLE BASIC OPERATIONS (cont'd)

VIDEO SIGNAL CONTROLS

Use these buttons for video signal control.

UNDER SCAN

Press the UNDER SCAN button to reduce the size of display area so that the whole picture is displayed on screen. Use to check the picture frame.

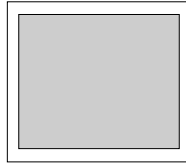

COLOR OFF

To display a black and white picture, press the COLOR OFF button to input the luminance signal only. Use to check noise in the luminance signal or for white balance adjustment.

Note:

- No effect with RGB input.

BLUE CHECK

Input the standard color-bar signal for your TV system and display it on the screen. When the BLUE CHECK button is pressed, the red and green signals are cut and only the blue signal is displayed. The BLUE CHECK function adjusts and checks CHROMA (COLOR) GAIN and PHASE.

Make sure that COMPO. LEVEL has been initialized when a component signal is input.

[Procedure]

1. Input the standard color-bar signal for your TV system and display it on the screen.
2. Press the BLUE CHECK button.
3. Press the CHROMA button to adjust the chroma so that the blue bars on the left and right sides of the screen have the same brightness.
4. (Only when an NTSC signal is input) Press the PHASE button to adjust the phase so that the two blue bars at the center of the screen have the same brightness.
5. (Only when an NTSC signal is input) Repeat procedures 3 and 4 for the adjustment so that all four blue bars on the screen have the same brightness.

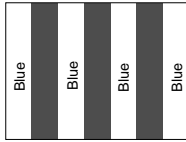

When you have finished making the adjustment, press the BLUE CHECK button to deactivate.

Initializing COMPO. LEVEL (when a component signal is input) with the IF-C01COMG component/RGB input card inserted

When a component signal is input, be sure to adjust (initialize) the COLOR offset in COMPO. LEVEL.

[Procedure]

1. Input the standard color-bar signal for your TV system and display it on the screen.
2. Press the BLUE CHECK button.
3. Select COMPO. LEVEL in the <MENU> screen and then adjust it with VOLUME +/- buttons so that the blue bars on the left and right sides of the screen have the same brightness.
4. Quit the <MENU> screen and press the BLUE CHECK button.
5. Make sure that the blue bars on the left and right sides of the screen have the same brightness.
6. Repeat procedures 3, 4 and 5 for the adjustment so that the blue bars on the left and right sides of the screen have the same brightness.

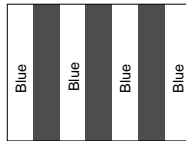

HOW TO USE THE MENU FUNCTIONS

DISPLAY AND SELECTION IN THE <MENU> SCREEN MODE (SETTING)

You can set the following menu items. Set them depending on your needs.

- APERTURE
- ADJ. BAR POSI.
- COLOR TEMP.
- COLOR SYSTEM
- COMPO. LEVEL*
- RUSH DELAY

1. Press the MENU button.



The <MENU> screen is displayed. * The on-screen display goes off automatically after about five minutes with operation performed.

2. Press the CHROMA/PHASE or CONTRAST/BRIGHT button to select MENU items.

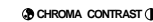

A selection mark (▶) is put next to the selected item.

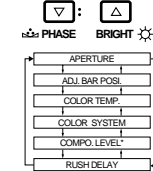

Front panel button	Function displayed	Contents
CHROMA/PHASE	▼	Forward selection mark (▶)
CONTRAST/BRIGHT	▲	Reverse selection mark (▶)

3. Press the VOLUME/SELECT buttons to set.



Front panel button	Function displayed	Contents
VOLUME/SELECT (+)	+	Increase (to max. value)
VOLUME/SELECT (+)	▶	Forward the setting value
VOLUME/SELECT (-)	-	Decrease (to min. value)
VOLUME/SELECT (-)	◀	Reverse the setting value

Menu items	Purpose	Setting range
APERTURE	Picture aperture level	00 ↔ +01 ↔ +39 ↔ +40
ADJ. BAR POSI	Volume bar position	LOWER ↔ UPPER
COLOR TEMP.	Color temperature of white balance	6500 ↔ 9300
COLOR SYSTEM	Color system	AUTO ↔ NTSC ↔ AUTO ↔ PAL
COMPO. LEVEL*	Component level	-40 ↔ -39 ↔ -01 ↔ 00 ↔ +1 ↔ +9 ↔ +10
RUSH DELAY	Delay time	STD. ↔ SLOW

* For normal use, leave the COLOR SYSTEM setting to AUTO. If reception is unsatisfactory in AUTO position, set it to the appropriate color system mode (NTSC or PAL). * COMPO. LEVEL is displayed only with COMPONENT (SDI) input. (Shown with INPUT-C and INPUT-D except for RGB input.)

4. If you want to set the other menu items, repeat procedures 2 and 3.

5. Press the MENU button to quit.



Front panel button	Function displayed	Contents
MENU	EXIT	Quit (or Release) the <MENU> screen

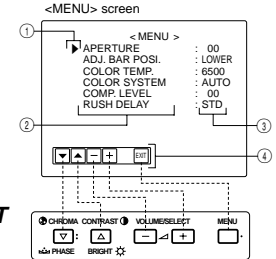

<Front panel buttons>

- ① Selection mark (▶): Indicates the menu item you select.
- ② Menu item: Menu items you can select.
- ③ Setting display: Indicates the current settings (value).
- ④ Function display: The functions of the front panel buttons (5 buttons on the left) correspond to the function displayed.

Function displayed	Contents
▼	Forward the menu item.
▲	Reverse the menu item.
-	Lower the adjustment value. (to the minimum)
+	Raise the adjustment value. (to the maximum)
▶	Forward the setting value.
◀	Reverse the setting value.
EXIT	Exits the <MENU> screen.

<ADJ. BAR POSI> screen UPPER

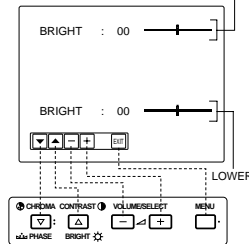

<Front panel buttons>

The upper screen; when setting "UPPER" in "ADJ. BAR POSI." The lower screen; when setting "LOWER" in "ADJ. BAR POSI."

HOW TO USE THE MENU FUNCTIONS (cont'd)

DISPLAY AND SELECTIONS IN THE <SET-UP MENU> MODE (SETTING)

- You can set the following set-up menu items.
- PICTURE SUB ADJ.
 - H. POSITION
 - V. POSITION
 - WHITE BALANCE
 - CONTROL LOCK
 - STATUS DISPLAY
 - REMOTE SYSTEM
 - INPUT REMOTE

Notes:

- Parameters for H. POSITION and V. POSITION can be set separately depending on the signal (Input A (VIDEO), Input B (VIDEO), Input C or Input D) selected with the input select buttons on the front panel. Select the required video input with the input select buttons on the front panel in advance.
- WHITE BALANCE can be set independently at 6500 or 9300 for the color temperature value. Set COLOR TEMP. to 6500 or 9300 on the <MENU> screen beforehand.
- INPUT REMOTE is shown when REMOTE SYSTEM is set to MAKE.

1. While pressing the MENU button, press the CHROMA/PHASE button.

- ① CHROMA / MENU
② PHASE / BRIGHT
- The <SET-UP MENU> screen is displayed.
* The on-screen display goes off automatically after about five minutes with operation performed.

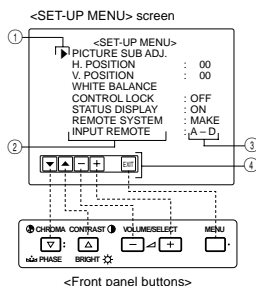

- ① Selection mark (▶): Indicates the menu item you select.
- ② Menu item: Menu items you can select.
- ③ Setting display: Indicates the current settings (value).
- ④ Function display: The functions of the front panel buttons (5 buttons on the left) correspond to the function displayed.

2. Press the CHROMA/PHASE or CONTRAST/BRIGHT button to select the desired menu item.

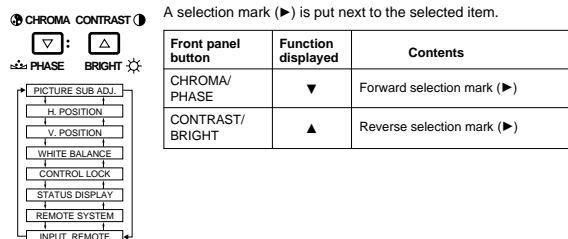

3. Press the VOLUME/SELECT buttons to set.

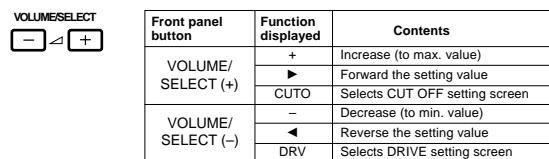

Notes:

- For WHITE BALANCE items, select the CUT OFF or DRIVE setting screen, then select the function display for adjustment.
- Press the EXIT (MENU) button to return to the <SET-UP MENU> screen.

Set-up menu items	Purpose	Settings
PICTURE SUB ADJ.	Image sub adjustment	Selects CONTRAST/BRIGHT/CHROMA/PHASE. The selected setting screen is shown. Select the function display for adjustment.
CONTRAST	Adjusts contrast.	-10 ↔ -9 ↔ ... ↔ -01 ↔ 00 ↔ +01 ↔ ... ↔ +09 ↔ +10
BRIGHT	Adjusts brightness.	-10 ↔ -9 ↔ ... ↔ -01 ↔ 00 ↔ +01 ↔ ... ↔ +09 ↔ +10
CHROMA	Adjusts color density.	*1 -10 ↔ -9 ↔ ... ↔ -01 ↔ 00 ↔ +01 ↔ ... ↔ +09 ↔ +10
PHASE	Adjusts hue.	*1 -10 ↔ -9 ↔ ... ↔ -01 ↔ 00 ↔ +01 ↔ ... ↔ +09 ↔ +10
H. POSITION	Adjusts the horizontal position of the screen (+: Horizontal position shifts to the right/-: Horizontal position shifts to the left)	-5 ↔ ... ↔ -01 ↔ 00 ↔ +1 ↔ ... ↔ +5
V. POSITION	Adjusts the vertical position of the screen (+: Vertical position moves up/-: Vertical position moves down)	-5 ↔ ... ↔ -01 ↔ 00 ↔ +1 ↔ ... ↔ +5
WHITE BALANCE	Adjusts the white balance.	Selects the drive (DRV) or cut off (CUTO) adjustment. The selected setting screen is shown. Select the function display for adjustment.
DRIVE	R. DRIVE B. DRIVE	Adjusts red level. Adjusts blue level.
CUT OFF	R. CUT OFF G. CUT OFF B. CUT OFF	Adjusts red cut off. Adjusts green cut off. Adjusts blue cut off.
CONTROL LOCK	Sets the operation buttons on the front panel to control lock mode.	OFF ↔ ON
STATUS DISPLAY	Sets the status display of the color system.	OFF ↔ ON
REMOTE SYSTEM	Sets the external control function method.	MAKE ↔ TRG. *2
INPUT REMOTE	Sets external control of input selection. (Shown only when REMOTE SYSTEM is set to MAKE.)	A-D ↔ A/B *2

- *1 May not be shown depending on the type of signals input.
*2 Refer to HOW TO USE EXTERNAL CONTROL on page 17 for more details.

4. To set the other set-up menu items, repeat the procedures 2 and 3.

5. Press the MENU button to quit.

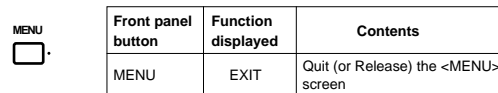

Note:

Setting	Description
MAKE	Make contact system: Controls the function with H and L (short-circuits or opens 15th terminal (GND)).
TRG.	Trigger system: Controls the function by short-circuiting (short-circuits or opens 15th terminal (GND)) with pulse (about 1 sec.)
A-D	Switches the input by short-circuiting a specified signal line in INPUT A, B, C, or D.
A/B	Switches between INPUT A and INPUT B with D-sub pin 2.

(Also, refer to HOW TO USE EXTERNAL CONTROL on page 17.)

Notes:

- When the CONTROL LOCK function is set to ON, pressing operation buttons on the front panel will display the message "CONTROL LOCK ON!" on the screen for about 3 seconds.
- The CONTROL LOCK function is maintained even when the power is turned off.
- To turn off the CONTROL LOCK function, while holding the MENU button, press the CHROMA/PHASE button. Then set the CONTROL LOCK function to OFF.
- Even when the CONTROL LOCK function is set to ON, the following operations are available:
 - Power Switch operation
 - Volume control with the VOLUME/SELECT buttons
 - Display or disappear of the <SET-UP MENU> screen.
- The STATUS DISPLAY function can be set to display (ON) or not display (OFF) the present color system when the power is turned on or the input signal is changed. Refer to page 9 for more information.
- When REMOTE SYSTEM is set to MAKE and any one of the INPUT A to D buttons, the UNDER SCAN button, COLOR OFF button or the ASPECT button is pressed, "REMOTE ON!" appears on screen for about 3 seconds. (Not shown with CONTROL LOCK set to ON.)
- When REMOTE SYSTEM is set to TRG, the front panel controls can be operated.
- INPUT REMOTE and REMOTE SYSTEM are enabled when REMOTE ENABLE is set to ON.

HOW TO INITIALIZE THE SETTING

SCREEN DISPLAY AND SELECTIONS IN THE <SET-UP MENU> RESET MODE

You can set <MENU> and <SET-UP MENU> screen items, picture adjustment items and the volume level to their factory-set (initial) values.

1. Press the Power (⏻) switch to turn the power OFF (activate the standby mode).



2. While pressing both MENU button and CHROMA/ PHASE button, press the Power (⏻) switch to turn the power ON.



The <SET-UP MENU> RESET screen is displayed.
* The screen automatically disappears when no operation is performed after about 5 minutes.

Note:

• The <SET-UP MENU> RESET screen will not be displayed if the MENU or CHROMA/PHASE buttons are pressed for a very short time. Keep pressing them until the display screen appears.

3. Setting

● Initialization is required.



Press the VOLUME/SELECT [+] button.
* Initialization is completed, and the <SET-UP MENU> RESET screen disappears.

● Initialization is not required.



Press the MENU button.
* Initialization is aborted, and the <SET-UP MENU> RESET screen disappears.

<SET-UP MENU> RESET screen

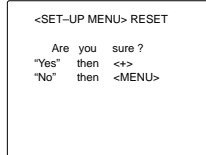

Initial settings

Sorts	Functions (Items)	Initialization (setting)
<MENU> screen	APERTURE	00
	ADJ. BAR POSI	LOWER
	COLOR TEMP	6500
	COLOR SYSTEM	AUTO
	COMPO. LEVEL	00
	RUSH DELAY	STD
<SET-UP MENU> screen	PICTURE SUB ADJ.	
	CONTRAST	00
	BRIGHT	00
	CHROMA	00
	PHASE	00
	H. POSITION	00
	V. POSITION	00
	WHITE BALANCE	
	R. CUT OFF	00
	G. CUT OFF	00
	B. CUT OFF	00
	R. DRIVE	00
	B. DRIVE	00
	CONTROL LOCK	OFF
STATUS DISPLAY	ON	
REMOTE SYSTEM	MAKE	
INPUT REMOTE	A - D	
Picture adjustment	CHROMA	00
	PHASE	00
	CONTRAST	00
	BRIGHT	00
Volume	VOLUME	20

BASIC CONNECTION EXAMPLE

Notes:

- Before connecting your system, make sure that all units are turned off.
- The illustration below shows some examples of different connections. Terminal connections may differ depending on the component connected. Be sure to refer to the instructions provided with the unit(s) you are connecting.
- Each pair of input (IN) and output (OUT) terminals are bridge-connected.
- If you're not connecting any equipment to a bridged output (OUT) terminal, be sure not to connect any other cables to the bridged output (OUT) terminal as this will cause the terminating resistance switch to open (auto terminate function).
- When making a bridge connection, connect the input (IN) and output (OUT) terminals on the monitor to separate video components. (For example, if both terminals are connected to the same VCR, resonance may occur except during playback. This is caused by the same video signal "looping" between the VCRs, and is not a malfunction.)
- Select the video input signal (INPUT A(VIDEO) or INPUT B (VIDEO/Y/C)) with the INPUT SELECT buttons on the front panel. When both VIDEO B terminals are connected (input) at the same time, the Y/C terminal has priority.

■ VIDEO A Connection Example (Select Input A (VIDEO))

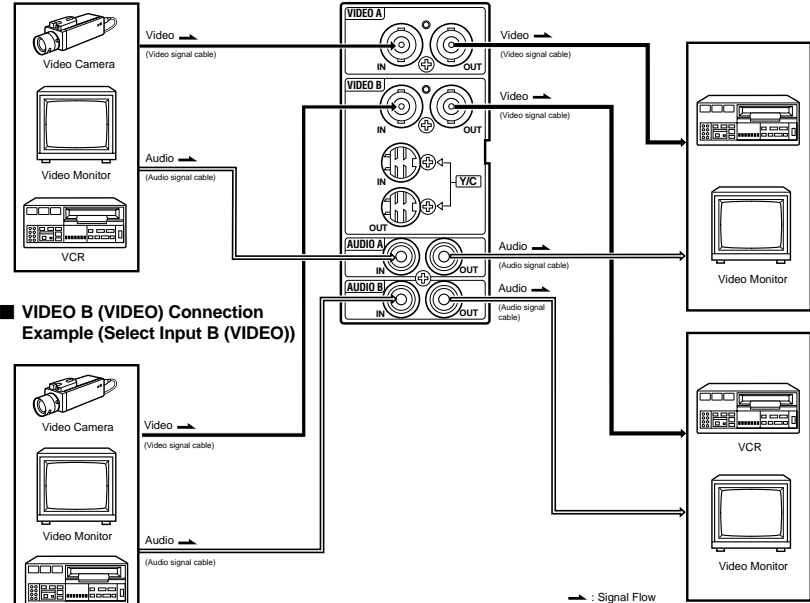

■ VIDEO B (VIDEO) Connection Example (Select Input B (VIDEO))

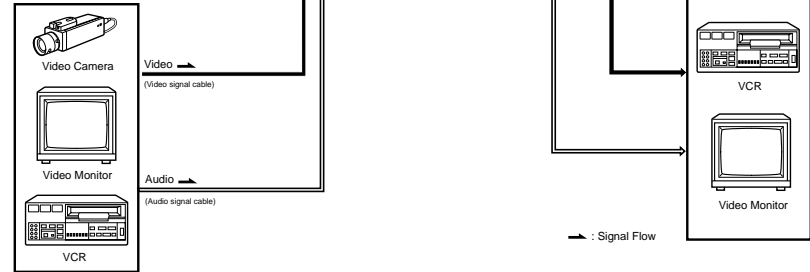

ENGLISH

BASIC CONNECTION EXAMPLE (cont'd)

VIDEO B (Y/C) Connection Example (Select Input B (Y/C))

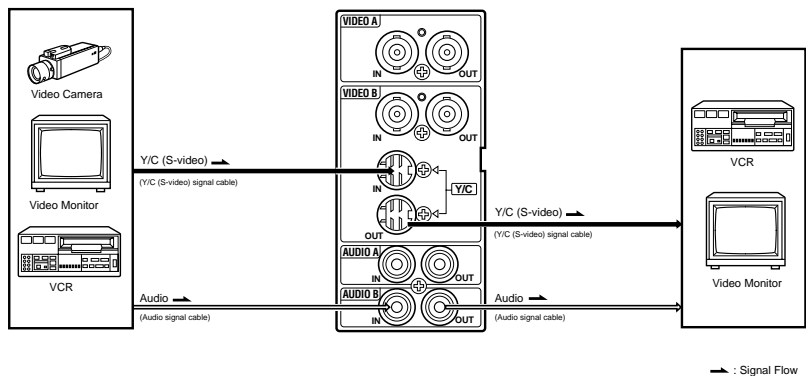

No. 51923

HOW TO USE EXTERNAL CONTROL

ABOUT EXTERNAL CONTROL

This monitor is provided with an external control terminal. MAKE (make contact) or TRG. (trigger) system can be selected. (MAKE (make contact system): The function is controlled with H and L (short-circuit/open with the 15th pin GND). (TRG. (trigger system): The function is controlled by short-circuiting with pulses (for about 1 second) (short-circuit/open with the 15th pin GND).

* The 14th pin (REMOTE ENABLE) is controlled with MAKE even though TRG. is selected.

Note:

- When this monitor is externally controlled, the following buttons are disabled.
MAKE: INPUT-A to D, UNDER SCAN, COLOR OFF, ASPECT on the front panel.

Connections

Connect (short-circuit) the 15th terminal (GND) to each of the 1st through 14th terminals in the 3-lines 15-pins D-sub connector. The functions of each terminal are listed below.

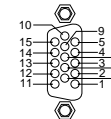

The Names and Functions of Terminals

No.	Names	Functions	Operations (OFF ↔ ON)		*1	
1	TALLY	Puts on the tally lamp.	Put off	Put on		
2	INPUT A	Changes the input to INPUT A	Not change	Change	*2	*8
3	INPUT B	Changes the input to INPUT B	Not change	Change	*3	*8
4	INPUT C	Changes the input to INPUT C	Not change	Change	*4	*8
5	INPUT D	Changes the input to INPUT D	Not change	Change	*5	*8
6	not used	—	—	—	*6	
7	not used	—	—	—	*6	
8	COLOR OFF	Changes the picture black-and-white.	Not change	Change		
9	not used	—	—	—	*6	
10	ASPECT	Changes the screen ratio to 16:9	4:3	16:9		
11	UNDER SCAN	Makes the screen under-scan	Over-scan	Under-scan		
12	not used	—	—	—	*6	
13	not used	—	—	—	*6	
14	REMOTE ENABLE	Makes the external control from the REMOTE terminal valid or invalid	Invalid	Valid	*7	
15	GND	Used as a ground terminal	—	—		

*1 : OFF stands for disconnection, and ON stands for short-circuit.

*2 : When INPUT REMOTE in the set-up menu is set to A/B, H: INPUT A and L: INPUT B are set.

*3 : When INPUT REMOTE in the set-up menu is set to A/B, pins not used should not be connected.

*4 : When INPUT REMOTE in the set-up menu is set to A/B, pins not used should not be connected.

*5 : When INPUT REMOTE in the set-up menu is set to A/B, pins not used should not be connected.

*6 : Do not connect.

*7 : Setting REMOTE ENABLE to ON enables remote control from the REMOTE terminal.

*8 : INPUT REMOTE setting in the set-up menu (REMOTE SYSTEM shown only when MAKE is selected.)

For the D-sub pins 2, 3, 4 and 5, 4-pin or 1-pin control can be set with INPUT REMOTE in the set-up menu.

• 4-pin control: Switches input by short-circuiting a specified signal line in INPUT A to D.

• 1-pin control: Switches between INPUT-A and INPUT-B only with the 2nd pin of the D-sub connector. In this case, INPUT-C and INPUT-D cannot be selected.

Open (H): INPUT-A

Short-circuit (L): INPUT-B

NOTE : When more than two terminals are selected (short-circuited) from INPUT A through INPUT D, signal input is prioritized alphabetically (A, B, C, D).
To control INPUT A through INPUT D, we recommend using the interlock switch, which turns off a switch when another switch is turned on.

ENGLISH

TROUBLESHOOTING

Solutions to common problems related to your monitor are described here. If none of the solutions presented here solves the problem, unplug the monitor and consult a JVC-authorized dealer or service center for assistance.

Problems	Points to be checked	Measures (Remedy)
No power supply.	Is the power plug loosened or disconnected?	Firmly insert the power plug.
	Is the main power turned OFF?	Turn the main power ON. (See page 6.)
No picture with the power on.	Is the video signal output from the connected component?	Set the connected component correctly.
	Is the input signal selected properly?	Select the required video signal input with the Input select button. (See page 9.)
	Is the video cable disconnected?	Connect the video signal cable firmly. (See pages 15 and 16.)
No sound.	Is the audio signal output from the connected component?	Set the connected component correctly.
	Is the volume output set to minimum?	Adjust the speaker volume with the VOLUME/SELECT button. (See page 9.)
	Is the audio cable disconnected?	Connect the audio signal cable firmly. (See pages 15 and 16.)
Shaking picture.	Is the monitor close to a device generating a strong magnetic field?	Move the device away from the monitor until the picture stabilizes.
No colors, wrong color, or dark picture.	Is the color system selected properly?	Set COLOR SYSTEM in the <MENU> screen to AUTO. (See page 11.)
	Has the picture control setting (CONTRAST, BRIGHT, CHROMA or PHASE) been changed?	Set each picture control to the standard setting. (See page 9.) Press the COLOR OFF button and BLUE CHECK button to adjust. (See page 10.)
Unnatural, irregularly colored, or distorted picture.	Is the monitor close to a speaker, magnet or any other device generating a strong magnetic field?	Move the device away from the monitor and turn the monitor's power off. Wait at least 30 minutes, then turn the power on again.
Dark stripes appear at the top and bottom of the screen, picture vertically squeezed.	Is the aspect ratio set to 16:9?	Switch the aspect ratio to 4:3 with the ASPECT button on the front panel.
The overall picture size is too small.	Has the UNDER SCAN button been pressed so the UNDER SCAN button lights?	Press the UNDER SCAN button to turn off the button. (See page 4.)
Function buttons on the front panel do not function.	Has control of the buttons been locked? (Has the CONTROL LOCK function been set to ON?)	Set CONTROL LOCK in the <SET-UP MENU> screen to OFF. (See pages 12 and 13.)
The INPUT SELECT buttons do not function.	Is input selection under external control? (Has the REMOTE ENABLE function been set to valid?)	Set REMOTE SYSTEM in the <SET-UP MENU> screen to TRG. (See pages 12 and 13.) Set REMOTE ENABLE to OFF (invalid). (See page 17.)

The following are not malfunctions:

- When a bright still image (such as a white cloth) is displayed for a long period, it may appear to be colored. This is due to the structure of the cathode ray tube and will be deleted when another image is displayed.
- You experience a mild electric shock when you touch the picture tube. This phenomenon is due to a normal buildup of static electricity on the CRT and is not harmful.
- The monitor emits a strange sound when the room temperature changes suddenly. This is only a problem if an abnormality appears on the screen as well.
- If two or more monitors are operated next to each other, their images may shake or be distorted. This phenomenon is due to mutual interference; it is not a malfunction. Move the monitors away from each other until the interference disappears or turn the power off on any monitor that is not being used.

SPECIFICATIONS

■ Type	: Color video monitor	■ Audio power output	: 1 W (monaural)
■ Color system	: PAL, NTSC (3.58)	■ Built-in speaker	: 8 cm round x 1 impedance of 8 Ω
■ Picture tube	: 16-3/16" (41 cm) measured diagonally, 90° deflection, in-line gun, trio-dot type (phosphor dot-trio pitch 0.27 mm)	■ Environmental conditions	: Operation temperature: 0°C – 40°C (32°F – 104°F) Operation humidity: 20 % – 80 % (non-condensing)
■ Effective screen size	: Width 12-7/8" (327.5 mm) Height 9-5/8" (246.2 mm) Diagonal 16-1/32" (407.1 mm)	■ Power requirements	: 120 V/230 V AC, 50 Hz/ 60 Hz
■ Scanning frequency	: (H) 15.734 kHz (NTSC) 15.625 kHz (PAL) (V) 59.94 Hz (NTSC) 50 Hz (PAL)	■ Power consumption	: 1.2 A (120 V AC)/0.8 A (230 V AC)
■ Horizontal resolution	: 750 TV lines or more	■ Dimensions	: Width 15-5/8" (395 mm) Height 13-1/4" (334 mm) Depth 16-1/2" (418.1 mm)
■ Input terminals		■ Weight	: 44.3 lbs (20.1 kg)
VIDEO A	: Composite video: 1 line, BNC connector x 2, 1 V(p-p), 75 Ω, negative sync (bridge connection possible, auto termination)	■ Accessory	: AC power cord
VIDEO B	: Composite video: 1 line, BNC connector x 2, 1 V(p-p), 75 Ω, negative sync (bridge connection possible, auto termination) Y/C-separated: 1 line, mini-DIN 4-pin connector x 2 Y: 1.0 V (p-p), 75 Ω C (BURST): 0.286 V (p-p), 75 Ω (NTSC) 0.3 V (p-p), 75 Ω (PAL) (bridge connection possible, auto termination)		
AUDIO A	: 1 line (monaural), RCA pin x 2 0.5 V(rms), high-impedance (bridge connection possible)		
AUDIO B	: 1 line (monaural), RCA pin x 2 0.5 V(rms), high-impedance (bridge connection possible)		
REMOTE	: Point-of-contact connection, 1 line D-sub connector (15-pin, 3-line)		

* Illustrations used in this manual are for explanatory purposes only. The appearance of the actual product may differ slightly.

* Dimensions and weight are approximate.

* E. & O. E. Design and specifications subject to change without notice.

■ Dimensions

Unit : inch (mm)

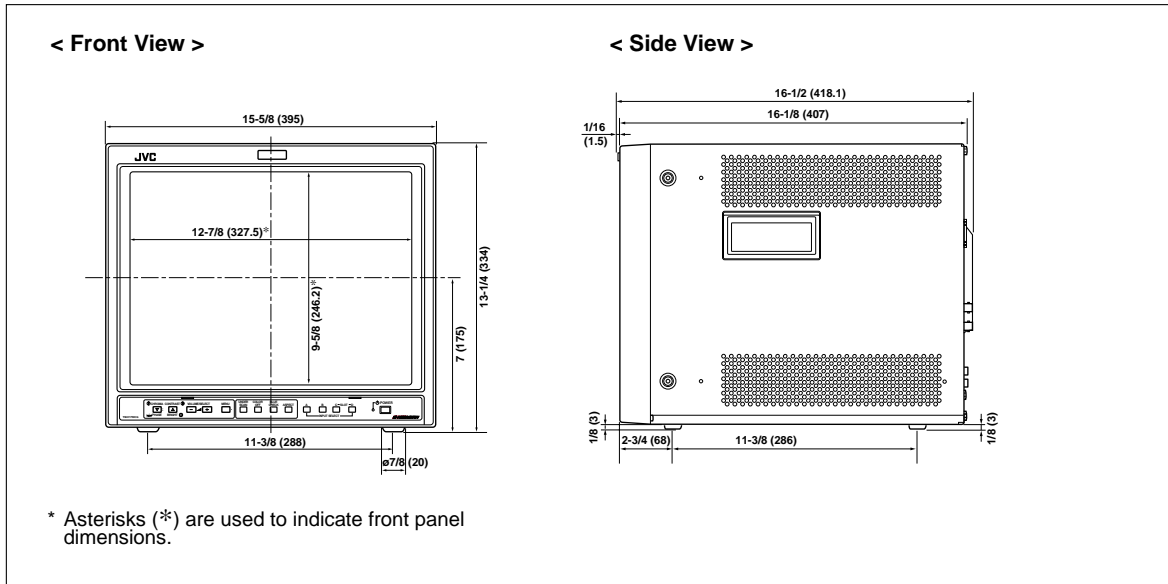

■ Y/C (Mini DIN 4 pin) terminal specification

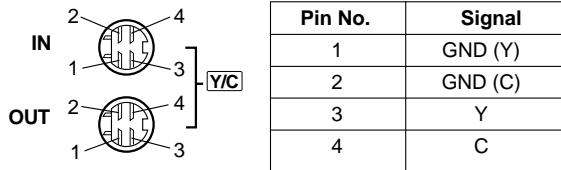

APPENDIX: CONNECTION EXAMPLES FOR THE SDI INPUT CARD

- To use the SWITCHED OUT terminal, the main power must be ON. (Unlike a bridged output, this connector outputs relocked digital signals.)
- Signals output from the SWITCHED OUT terminal can be selected with INPUT-C (SDI-1) and INPUT-D (SDI-2) buttons on the front panel (or remote control).
- When INPUT-A or INPUT-B is selected, this terminal outputs the signals last selected. In the standby mode, signals from the SDI 1 connector are output.